



Highways Safety Solutions

www.glasdon.com

Highways Bollards	3-19
Sign Carrying Bollards	20-27
Recycled Material Bollards	28-30
Road Safety Signs	31-34
Road Safety Vergeposts	35-42
Gateway Sign Carriers	43-45
Other Road Safety Products	46-47
Fixing Options	48-50
High Performance Materials	51
Photo Gallery	52-55

Passively Safe

Passively safe street furniture is designed to minimise the severity of injury to occupants of a vehicle that collides with it. The European Standard BS EN 12767 defines a universal test that establishes the performance of a passively safe roadside structure.

The performance rating is displayed in the following format:

The first number indicates the class impact speed in kph: 50, 70 or 100kph. Tests are conducted with a small (900kg) car in a head-on, frontal impact.

The two letters represent the energy absorbed by the structure: High energy absorbing (HE) support structures slow the vehicle considerably on impact; Low energy (LE) structures measurably slow the vehicle but pose a much lower risk of injury to its occupants; Non-energy absorbing (NE) structures have negligible or nil effect on the speed of the vehicle.

The final number represents the occupant safety level and is based on the Acceleration Severity Index (ASI) and Theoretical Head Impact Velocity (THIV) scales, according to European Standard BS EN 1317-1. The available levels are 1-4, where Level 4 represents the safest and Level 1 the most dangerous.

Glasdon passively safe highways products are tested by accredited independent specialists at MIRA and TRL.

Where testing has been conducted, the performance rating will be clearly shown on the page.



Highways Bollards

At Glasdon we have been designing and manufacturing bollards for more than 40 years. Our versatile road safety solutions are used all over the highways and byways of the United Kingdom, and we like to think we have a product for every application. With a variety of traditional and modern styles, in rigid Durapol® material and flexible Impactapol® material and also a wide choice of fixing options to suit your requirements.



Advanced Neopolitan™ 150 Bollard

DESIGN FEATURES

- Available as a self-righting Rebound bollard or rigid Durapol® Material model.
- Choice of two fixing options - LockFast Socket System or permanent below-ground extended base fixing.
- Large 150mm reflective top patches.
- Larger 40mm lower reflector catches dipped headlights.
- Individual reflectors offer enhanced drive-through performance.
- LockFast Socket allows quick and easy bollard top replacement.
- Optional socket blanking cap available.

SPECIFICATIONS

Height above ground:	925mm
Maximum diameter:	200mm
Socket depth below ground:	350mm
Extended base depth below ground:	300mm

*Rebound Impactapol model only.



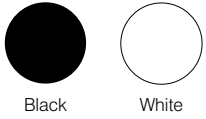

MATERIAL & COLOUR OPTIONS

Bollard: Passively safe Impactapol Material or rigid Durapol Material

LockFast Socket: Durapol Material.

Durapol Material and Passively Safe Rebound Impactapol Material: Black, White.

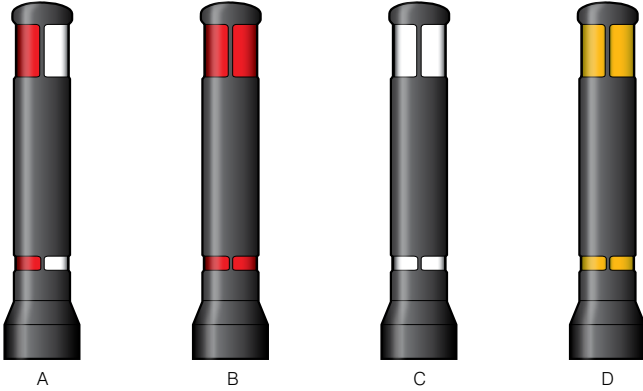

OPTIONAL BANDING

- A. 2 x 150mm and 2 x 40mm Red/White retroreflective patches*
- B. 2 x 150mm and 2 x 40mm Red retroreflective patches*
- C. 2 x 150mm and 2 x 40mm White retroreflective patches*
- D. 2 x 150mm and 2 x 40mm Amber retroreflective patches*

*All retroreflective materials supplied by Glasdon UK are as recommended in table NA1 of the National Annex of BS EN 12899-1:2007 Fixed Vertical Road Signs.

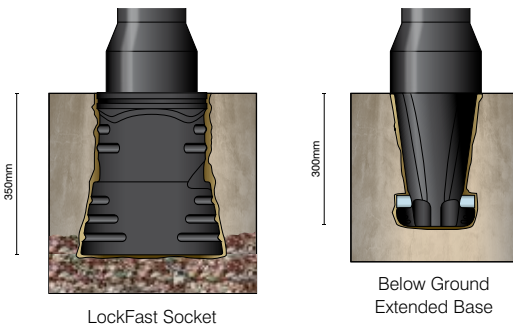

FIXING OPTIONS

Durapol Material and Passively Safe Rebound Impactapol Material: LockFast Socket, Below Ground Extended Base.





■ Glasdon Manchester™ Bollard

DESIGN FEATURES

- Available as a self-righting Rebound bollard or rigid Durapol material model.
- Never requires painting - unlike cast iron equivalents.
- A fraction of the weight of a metal bollard - can be installed by one person.
- Existing cast iron bollards can be replaced over time to save cost.
- Recessed areas for retroreflective or decorative banding.
- LockFast Socket allows quick and easy bollard top replacement.
- Optional socket blanking cap available

SPECIFICATIONS

Height above ground:	1005mm
Maximum diameter:	220mm
Socket depth below ground:	350mm
Extended base depth below ground:	300mm

*Rebound Impactapol model only.





Black

MATERIAL & COLOUR OPTIONS

Bollard: Passively safe Impactapol Material or rigid Durapol Material.

LockFast Socket: Durapol Material.

Durapol Material and Passively Safe Rebound Impactapol Material: Black.



OPTIONAL BANDING

A. 1 x 63mm and/or up to 3 x 12mm Red/White retroreflective bands*

B. 1 x 63mm and/or up to 3 x 12mm Red retroreflective bands*

C. 1 x 63mm and/or up to 3 x 12mm White retroreflective bands*

D. 1 x 63mm and/or up to 3 x 12mm Amber retroreflective bands*

E. 1 x 63mm and/or up to 3 x 12mm Gold Decorative bands

*All retroreflective materials supplied by Glasdon UK are as recommended in table NA1 of the National Annex of BS EN 12899-1:2007 Fixed Vertical Road Signs.

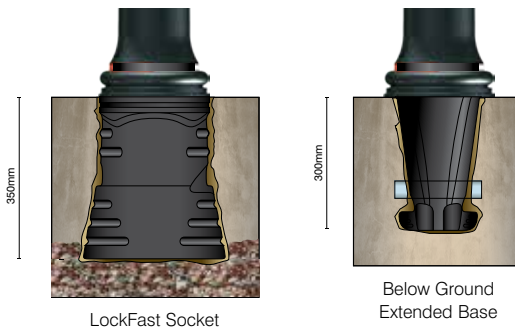

FIXING OPTIONS

Durapol Material and Passively Safe Rebound Impactapol Material: LockFast Socket, Below Ground Extended Base.





Neopolitan™ 150 Bollard

DESIGN FEATURES

- Available as a self-righting Rebound bollard or rigid Durapol material model.
- Recessed areas for retroreflective or decorative banding.
- Wide range of fixing options available.
- Optional socket blanking cap available.

SPECIFICATIONS

Height above ground:	925mm
(socketed/extended base/guardsman models)	1005mm
(bolt-down)	200mm
Maximum diameter:	500mm
Socket depth below ground:	420mm
Extended base depth below ground:	745mm
Guardsman fixing depth below ground:	300mm
Bridgmaster fixing depth below ground:	75mm
Bolt-down fixing depth:	320mm
Adjustable depth concrete-in anchors:	
Maximum depth:	

*Rebound Impactapol model only.



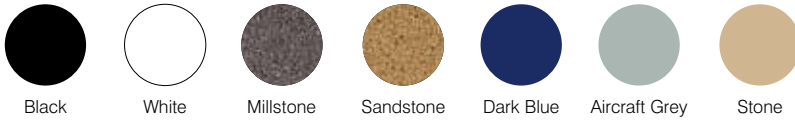

MATERIAL & COLOUR OPTIONS

Bollard: Passively safe Impactapol Material or rigid Durapol Material.

Socket: Durapol Material.

Durapol Material: Black, White, Millstone, Sandstone, Dark Blue, Aircraft Grey, Stone.

Passively Safe Rebound Impactapol Material: Black, White.

(Some colours are subject to a minimum order quantity. Please telephone our Sales Office for details.)

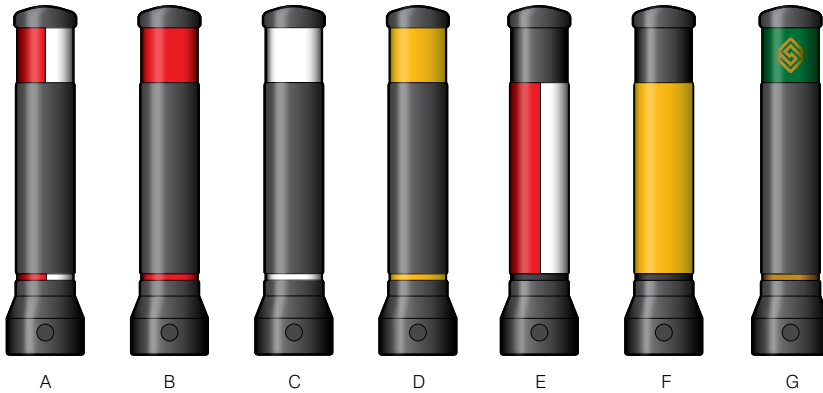

OPTIONAL BANDING

A. 1 x 150mm and 1 x 20mm Red/White retroreflective bands*

B. 1 x 150mm and 1 x 20mm Red retroreflective bands*

C. 1 x 150mm and 1 x 20mm White retroreflective bands*

D. 1 x 150mm and 1 x 20mm Amber retroreflective bands*

E. 1 x 485mm Red/White body sleeve (3 x 150mm bands are available for use with Rebound model)*

F. 1 x 485mm Amber body sleeve (3 x 150mm bands are available for use with Rebound model)*

G. 1 x 150mm and 1 x 20mm decorative bands

150mm band is ideal for personalisation with your crest, logo or message.

*All retroreflective materials supplied by Glasdon UK are as recommended in table NA1 of the National Annex of BS EN 12899-1:2007 Fixed Vertical Road Signs.

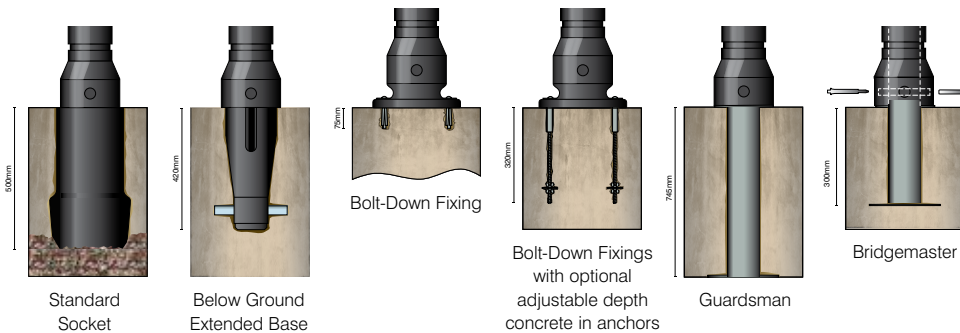

FIXING OPTIONS

Durapol Material: Standard Socket, Below Ground Extended Base, Bolt-Down Fixing, Bolt-Down Fixings with optional adjustable depth concrete in anchors, Guardsman, Bridgemaster.

Passively Safe Rebound Impactapol Material: Below Ground Extended Base, Bolt-Down Fixing and Bolt-Down Fixings with optional adjustable depth concrete in anchors.





600mm High Neopolitan 150 Bollard

DESIGN FEATURES

- Designed for improved visibility at junctions.
- Rebound and rigid models available.
- Recessed areas for retroreflective or decorative banding.
- Co-ordinates with Neopolitan 150 and Neopolitan 20 Bollards

SPECIFICATIONS

Height above ground:	612mm
Maximum diameter:	200mm
Bolt-down fixing depth:	75mm
Adjustable depth concrete-in anchors:	
Maximum depth:	320mm

*Rebound Impactapol model only.



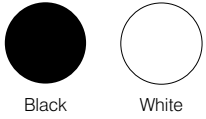

Black

White

MATERIAL & COLOUR OPTIONS

Bollard: Passively safe Impactapol Material or rigid Durapol Material
 Durapol Material and Passively Safe Rebound Impactapol Material: Black, White.

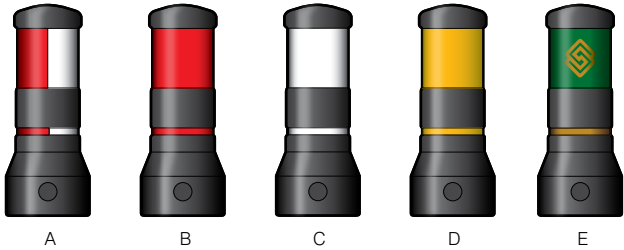

OPTIONAL BANDING

- A. 1 x 150mm and 1 x 20mm Red/White retroreflective bands*
- B. 1 x 150mm and 1 x 20mm Red retroreflective bands*
- C. 1 x 150mm and 1 x 20mm White retroreflective bands*
- D. 1 x 150mm and 1 x 20mm Amber retroreflective bands*
- E. 1 x 150mm and 1 x 20mm decorative bands

150mm band is ideal for personalisation with your crest, logo or message.

*All retroreflective materials supplied by Glasdon UK are as recommended in table NA1 of the National Annex of BS EN 12899-1:2007 Fixed Vertical Road Signs.

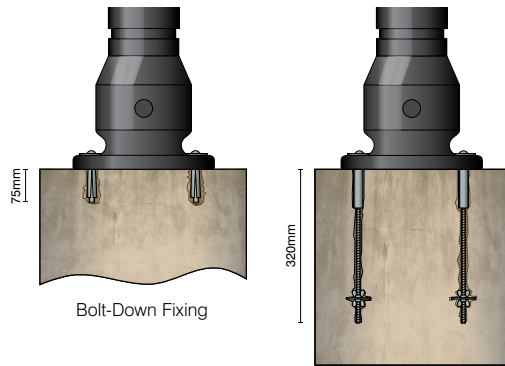

Bolt-Down Fixing

Bolt-Down Fixings with optional adjustable depth concrete in anchors

FIXING OPTIONS

Durapol Material and Passively Safe Rebound Impactapol Material: Bolt-Down Fixings, Bolt-Down Fixings with optional adjustable depth concrete in anchors.





Neopolitan 20 Bollard

DESIGN FEATURES

- Available as a self-righting Rebound bollard or rigid Durapol material model.
- Recessed areas for retroreflective or decorative banding.
- Wide range of fixing options available.
- Optional socket blanking cap available.

SPECIFICATIONS

Height above ground:	925mm
Maximum diameter:	200mm
Socket depth below ground:	500mm
Extended base depth below ground:	420mm
Guardsman fixing depth below ground:	745mm
Bridgmaster fixing depth below ground:	300mm
Bolt-down fixing depth:	95mm
Adjustable depth concrete-in anchors:	
Maximum depth:	250mm

*Rebound Impactapol model only.



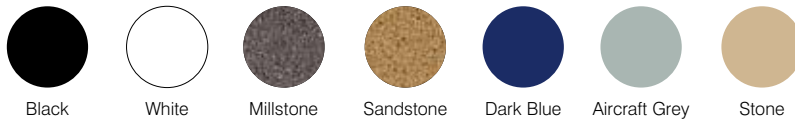

MATERIAL & COLOUR OPTIONS

Bollard: Passively safe Impactapol Material or rigid Durapol Material.

Socket: Durapol Material.

Durapol Material: Black, White, Millstone, Sandstone, Dark Blue, Aircraft Grey, Stone.

Passively Safe Rebound Impactapol Material: Black, White.

(Some colours are subject to a minimum order quantity. Please telephone our Sales Office for details.)

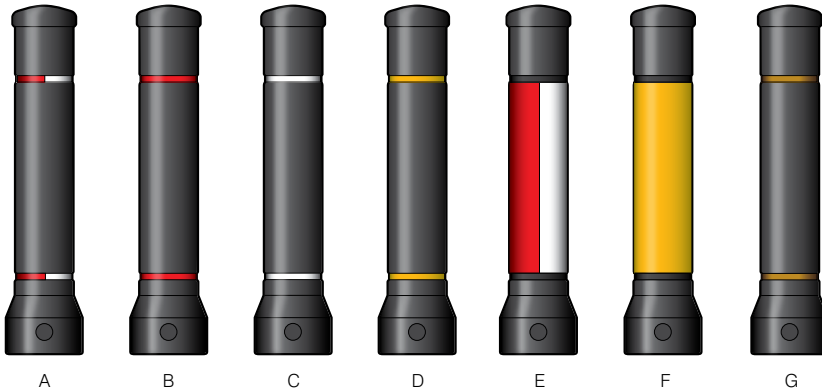

OPTIONAL BANDING

A. 2 x 20mm Red/White retroreflective bands*

B. 2 x 20mm Red retroreflective bands*

C. 2 x 20mm White retroreflective bands*

D. 2 x 20mm Amber retroreflective bands*

E. 1 x 485mm Red/White body sleeve (3 x 150mm bands are available for use with Rebound model)*

F. 1 x 485mm Amber body sleeve (3 x 150mm bands are available for use with Rebound model)*

G. 2 x 20mm Gold decorative bands

*All retroreflective materials supplied by Glasdon UK are as recommended in table NA1 of the National Annex of BS EN 12899-1:2007 Fixed Vertical Road Signs.

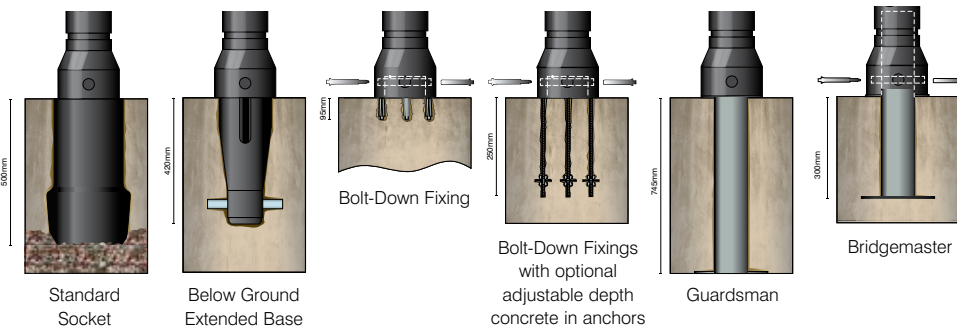

FIXING OPTIONS

Durapol Material: Standard Socket, Below Ground Extended Base, Bolt-Down Fixing, Bolt-Down Fixings with optional adjustable depth concrete in anchors, Guardsman, Bridgmaster.

Passively Safe Rebound Impactapol Material: Below Ground Extended Base.





Admiral™ Bollard

DESIGN FEATURES

- Available as a self-righting Rebound bollard or rigid Durapol material model.
- 80mm (Rigid) or 150mm (Rebound) banding recess.
- Optional socket blanking cap available.

SPECIFICATIONS

Height above ground:	936mm
Maximum diameter:	198mm
Socket depth below ground:	500mm
Extended base depth below ground:	300mm

*Rebound Impactapol model only.



Glasdon focus on Highly Visible Junction Marker Bollards for Somerset County Council.

What the Customer says:

"Somerset County Council have found the Admiral junction marker to be a useful tool in their armoury, as part of integrated route treatment works in rural locations. It has been effective in reducing road accident casualties and gives drivers enhanced information on road layouts and potential hazards."

Mr Nick Cowling, Team Leader Accident Data and Engineering, Somerset.



MATERIAL & COLOUR OPTIONS

Bollard: Passively safe Impactapol Material or rigid Durapol Material.

Socket: Durapol Material.

Durapol Material: Black, White, Millstone, Sandstone, Aircraft Grey, Stone.

Passively Safe Rebound Impactapol Material: Black, White.

(Some colours are subject to a minimum order quantity. Please telephone our Sales Office for details.)

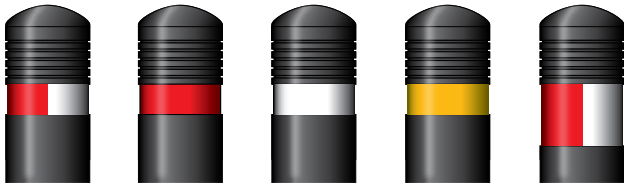

A B C D E*

OPTIONAL BANDING

- A. 1 x 80mm Red/White retroreflective band*
- B. 1 x 80mm Red retroreflective band*
- C. 1 x 80mm White retroreflective band*
- D. 1 x 80mm Amber retroreflective band*
- E. 1 x 150mm Red/White retroreflective band*

*All retroreflective materials supplied by Glasdon UK are as recommended in table NA1 of the National Annex of BS EN 12899-1:2007 Fixed Vertical Road Signs.

* Available with the self-righting Rebound model only.

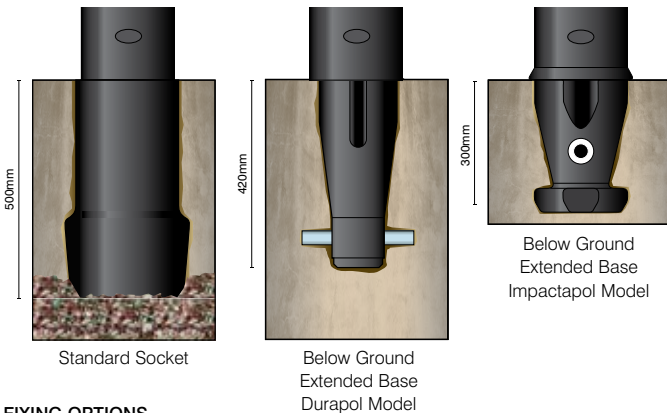

FIXING OPTIONS

Durapol Material: Standard Socket, Below Ground Extended Base.

Passively Safe Rebound Impactapol Material: Below Ground Extended Base.





■ Victory™ Bollard

DESIGN FEATURES

- Available as a self-righting Rebound bollard or rigid Durapol material model.
- Never requires painting - unlike cast iron equivalents.
- A fraction of the weight of a metal bollard - can be installed by one person.
- Recessed areas for retroreflective or decorative banding.
- Optional socket blanking cap available.

SPECIFICATIONS

Height above ground:	967mm
Maximum diameter:	200mm
Socket depth below ground:	500mm
Extended base depth below ground:	420mm

*Rebound Impactapol model only.





Black

MATERIAL & COLOUR OPTIONS

Bollard: Passively safe Impactapol Material or rigid Durapol Material.
Durapol Material and Passively Safe Rebound Impactapol Material: Black.

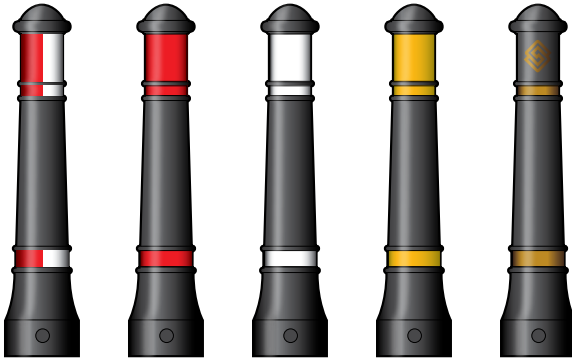

A

B

C

D

E

OPTIONAL BANDING

- A. 1 x 125mm and/or 1 x 20mm and/or 1 x 38mm Red/White retroreflective bands*
- B. 1 x 125mm and/or 1 x 20mm and/or 1 x 38mm Red retroreflective bands*
- C. 1 x 125mm and/or 1 x 20mm and/or 1 x 38mm White retroreflective bands*
- D. 1 x 125mm and/or 1 x 20mm and/or 1 x 38mm Amber retroreflective bands*
- E. 1 x 125mm and/or 1 x 20mm and/or 1 x 38mm Gold decorative bands
125mm band is ideal for personalisation with your crest, logo or message.

*All retroreflective materials supplied by Glasdon UK are as recommended in table NA1 of the National Annex of BS EN 12899-1:2007 Fixed Vertical Road Signs.

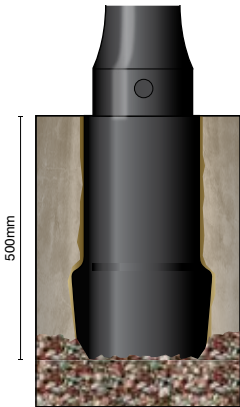

500mm

Standard Socket

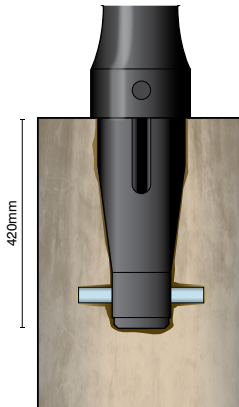

420mm

Below Ground
Extended Base

FIXING OPTIONS

Durapol Material: Standard Socket, Below Ground Extended Base.
Passively Safe Rebound Impactapol Material: Below Ground Extended Base.



Highways Bollards



Jubilee™ Bollard

DESIGN FEATURES

- Available as a self-righting Rebound bollard or rigid Durapol material model.
- Never requires painting - unlike cast iron equivalents.
- A fraction of the weight of a metal bollard - can be installed by one person.
- Versatile banding options.
- Optional socket blanking cap available.

SPECIFICATIONS

Height above ground:	942mm
Maximum diameter:	190mm
Socket depth below ground:	500mm
Extended base depth below ground:	420mm

*Rebound Impactapol model only.





Black

MATERIAL & COLOUR OPTIONS

Bollard: Passively safe Impactapol Material or rigid Durapol Material.
Durapol Material and Passively Safe Rebound Impactapol Material: Black.

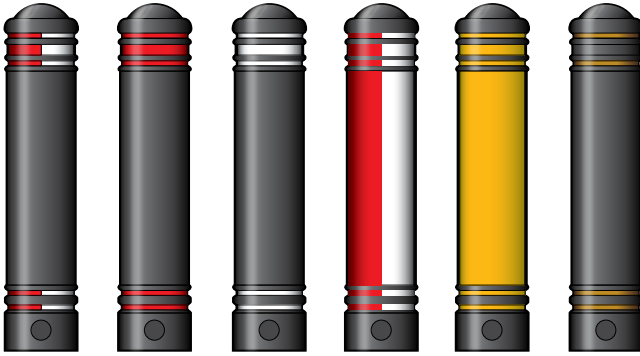

A B C D E F

OPTIONAL BANDING

- A. 4 x 12mm and/or 1 x 27mm Red/White retroreflective bands*
- B. 4 x 12mm and/or 1 x 27mm Red retroreflective bands*
- C. 4 x 12mm and/or 1 x 27mm White retroreflective bands*
- D. 1 x 580mm Red/White body sleeve, 4 x 12mm and 1 x 27mm retroreflective bands*
- E. 1 x 580mm Amber body sleeve, 4 x 12mm and 1 x 27mm retroreflective bands
- F. 4 x 12mm Gold decorative bands.

*All retroreflective materials supplied by Glasdon UK are as recommended in table NA1 of the National Annex of BS EN 12899-1:2007 Fixed Vertical Road Signs.

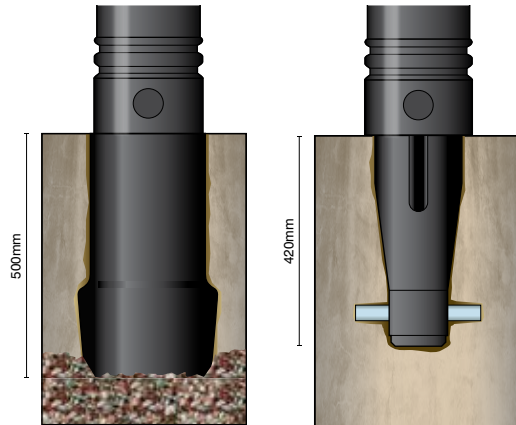

Standard Socket

Below Ground
Extended Base

FIXING OPTIONS

Durapol Material: Standard Socket, Below Ground Extended Base.
Passively Safe Rebound Impactapol Material: Below Ground Extended Base.



Highways Bollards

Sign Carrying Bollards

Warn, inform and protect road users, cyclists and pedestrians with Glasdon sign carrying bollards. Perfect for marking dedicated cycle paths and shared routes.

Rigid and rebound models are available to co-ordinate with our range of Neopolitan Bollards.



Infomaster™ Bollard

DESIGN FEATURES

- Rigid Durapol Material construction.
- Optimum height for drivers.
- Narrow footprint takes up minimal space on the pavement.
- Double-sided signface helps to reduce cost.
- Recessed signface deters vandalism.
- Easily re-sited.
- Choice of fixing options available.

SPECIFICATIONS

Height above ground: 1195mm
 Width: 370mm
 Sign face dimensions: 308mm x 248mm
 Bolt-down fixing depth: 75mm
 Adjustable depth concrete-in anchors:
 Maximum depth: 320mm

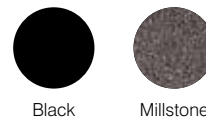

Black

Millstone

MATERIAL & COLOUR OPTIONS

Durapol Material in Black, Millstone.

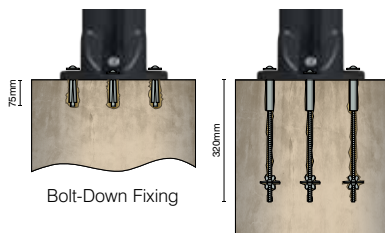

Bolt-Down Fixing

Bolt-Down Fixing with adjustable depth concrete in anchors

FIXING OPTIONS

Bolt-Down Fixing
 Bolt-Down Fixing with adjustable depth concrete in anchors



SIGNFACE OPTIONS

Available single or double sided and with optional side reflectors. Infomaster can be used for a range of applications, please see above for examples. To discuss your requirements please telephone our sales office on 1800 656 606.

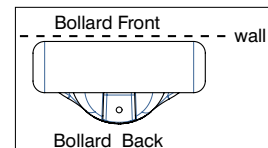

SIGNFACE ORIENTATION

If Infomaster is to be sited against a building/wall please specify that the signface is for the back of the bollard.



■ Ensign™ Bollard

DESIGN FEATURES

- Rigid Durapol Material construction.
- Wide range of signface options.
- Recessed areas for retroreflective or decorative banding.
- Choice of fixing options available.
- Optional socket blanking cap available.

SPECIFICATIONS

Height above ground:	
(socketed)	1120mm
(bolt-down)	1206mm
Width:	338mm
Maximum stem diameter:	200mm
Sign face diameter:	300mm
Socket depth below ground:	500mm
Extended base depth below ground:	420mm

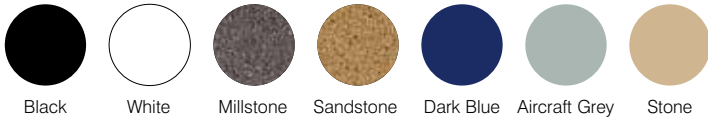

MATERIAL & COLOUR OPTIONS

Bollard: Rigid Durapol Material.

Socket: Durapol Material.

Durapol Material: Black, White, Millstone, Sandstone, Dark Blue, Aircraft Grey, Stone.

(Some colours are subject to a minimum order quantity. Please telephone our Sales Office for details.)

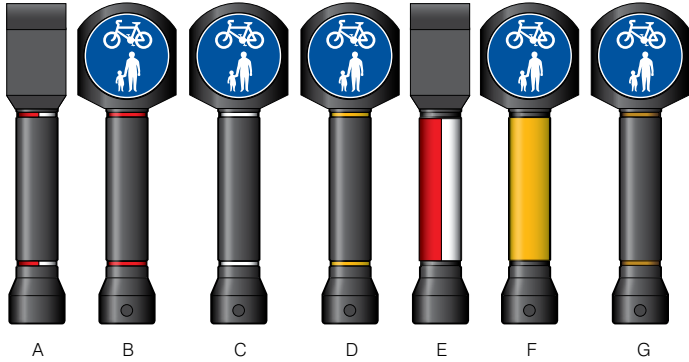

OPTIONAL BANDING

- A. 2 x 20mm Red/White retroreflective bands*
- B. 2 x 20mm Red retroreflective bands*
- C. 2 x 20mm White retroreflective bands*
- D. 2 x 20mm Amber retroreflective bands*
- E. 1 x 485mm Red/White body sleeve

- F. 1 x 485mm Amber body sleeve
- G. 2 x 20mm Gold decorative bands

*All retroreflective materials supplied by Glasdon UK are as recommended in table NA1 of the National Annex of BS EN 12899-1:2007 Fixed Vertical Road Signs.

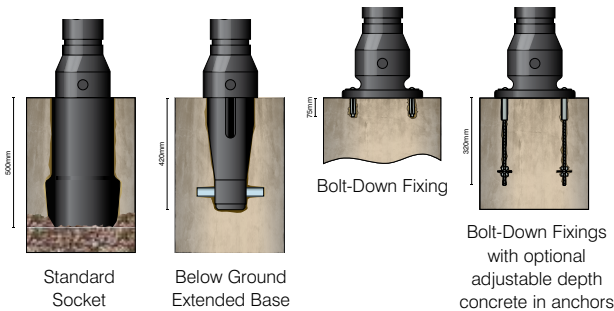

FIXING OPTIONS

Durapol Material: Standard Socket, Below Ground Extended Base, Bolt-Down Fixing, Bolt-Down Fixings with optional adjustable depth concrete in anchors.



Ensign Bollard also takes two 210mm x 125mm signs.



Ensign Bollard also takes two Ø150mm signs.

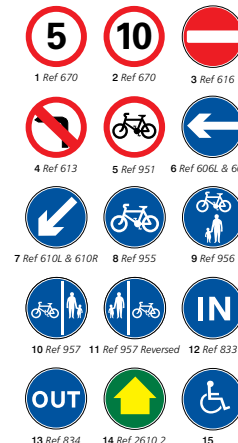

STANDARD PRICE SIGN OPTIONS

1. Max. Speed Limit (5mph)
2. Max. Speed Limit (10mph)
3. No Entry
4. No Left Turn
5. Cycles Prohibited
6. Turn Left
7. Keep Left
8. Cycle Route
9. Cycle/Pedestrians Only
10. Cycle/Pedestrians Only "Route Marked"
11. Cycle/Pedestrians Only "Route Marked" reversed
12. In*
13. Out*
14. Waymark
15. Disabled Sign

* For use on the public highway these options require prior approval from the DfT. All other standard options conform fully with the TSRGD.



Mini Ensign™ Bollard

DESIGN FEATURES

- Available as a self-righting Rebound bollard or rigid Durapol material model.
- Illuminated rebound model available.
- Wide range of signface options.
- Recessed areas for retroreflective or decorative banding.
- Choice of fixing options available.
- Optional socket blanking cap available.

SPECIFICATIONS

Height above ground:	1010mm
(socketed)	
(bolt-down)	1087mm
Maximum diameter:	200mm
Sign face diameter:	150mm
Socket depth below ground:	500mm
Extended base depth below ground:	420mm
Bolt-down fixing depth:	75mm
Adjustable depth concrete-in anchors:	
Maximum depth:	320mm

*Rebound Impactapol model only.



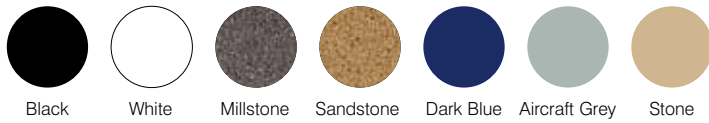

MATERIAL & COLOUR OPTIONS

Bollard: Passively safe Impactapol Material or rigid Durapol Material.

Socket: Durapol Material.

Durapol Material: Black, White, Millstone, Sandstone, Dark Blue, Aircraft Grey, Stone.

Passively Safe Rebound Impactapol Material: Black, White. Mini Ensign illuminated rebound bollard is only available in White.

(Some colours are subject to a minimum order quantity. Please telephone our Sales Office for details.)

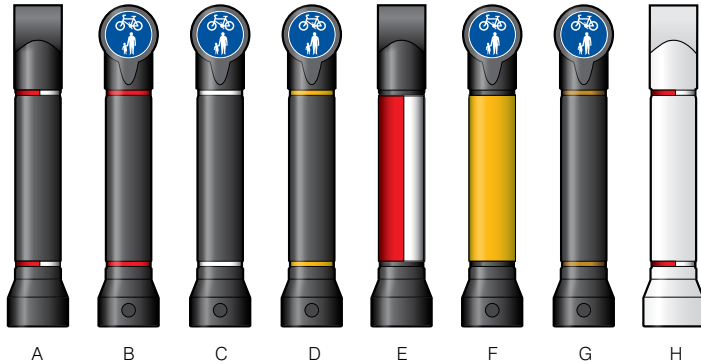

OPTIONAL BANDING

- A. 2 x 20mm Red/White retroreflective bands*
- B. 2 x 20mm Red retroreflective bands*
- C. 2 x 20mm White retroreflective bands*
- D. 2 x 20mm Amber retroreflective bands*
- E. 1 x 485mm Red/White body sleeve (3 x 150mm bands are available for use with Mini Ensign Rebound models.)*
- F. 1 x 485mm Amber body sleeve (3 x 150mm bands are available for use with Mini Ensign Rebound models.)*
- G. 2 x 20mm Gold decorative bands
- H. 2 x 20mm Red/White translucent retroreflective bands (for use with Mini Ensign illuminated rebound bollard)

*All retroreflective materials supplied by Glasdon UK are as recommended in table NA1 of the National Annex of BS EN 12899-1:2007 Fixed Vertical Road Signs.

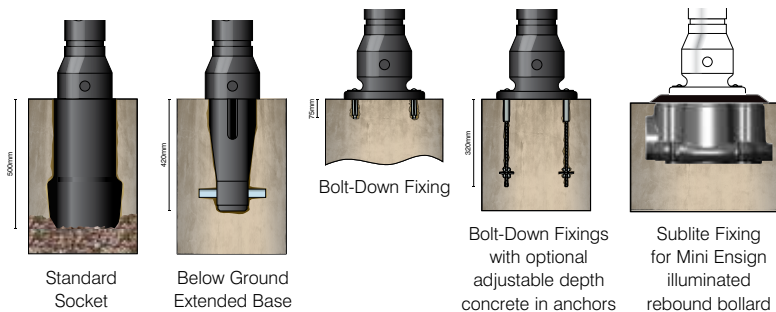

FIXING OPTIONS

Durapol Material: Standard Socket, Below Ground Extended Base, Bolt-Down Fixing, Bolt-Down Fixings with optional adjustable depth concrete in anchors.

Passively Safe Rebound Impactapol Material: Below Ground Extended Base, Bolt-Down Fixing and Bolt-Down Fixings with optional adjustable depth concrete in anchors, Sublite Fixing for Mini Ensign illuminated rebound bollard.



MINI ENSIGN ILLUMINATED BOLLARD

White Mini Ensign illuminated rebound bollard with Red/White translucent retroreflective bands.

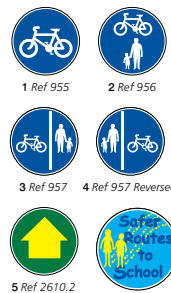

STANDARD PRICE SIGN OPTIONS

1. Cycle Route
2. Cycle/Pedestrians Only
3. Cycle/Pedestrians Only "Route Marked"
4. Cycle/Pedestrians Only "Route Marked" reversed
5. Waymark

Sign carrying bollards are also suitable for personalisation with safer routes to schools or your crest, logo or message. Please phone 1800 656 606 for more information.



Neoplitan Signhead™ Bollard

DESIGN FEATURES

- Available as a self-righting Rebound bollard or rigid Durapol material model.
- Wide range of signface options.
- Recessed areas for retroreflective or decorative banding
- Choice of fixing options available.
- Optional socket blanking cap available.

SPECIFICATIONS

Height above ground: (socketed)	1075mm
(bolt-down)	1156mm
Maximum diameter:	200mm
Sign face dimensions:	125mm x 210mm
Socket depth below ground:	500mm
Extended base depth below ground:	420mm
Bolt-down fixing depth:	75mm
Adjustable depth concrete-in anchors:	
Maximum depth:	320mm

*Rebound Impactapol model only.



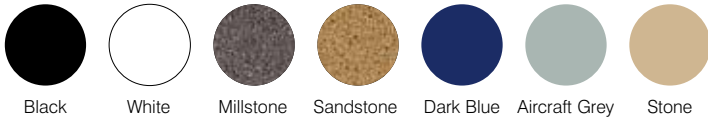

MATERIAL & COLOUR OPTIONS

Bollard: Passively safe Impactapol Material or rigid Durapol Material.

Socket: Durapol Material.

Durapol Material: Black, White, Millstone, Sandstone, Dark Blue, Aircraft Grey, Stone.

Passively Safe Rebound Impactapol Material: Black, White.

(Some colours are subject to a minimum order quantity. Please telephone our Sales Office for details.)

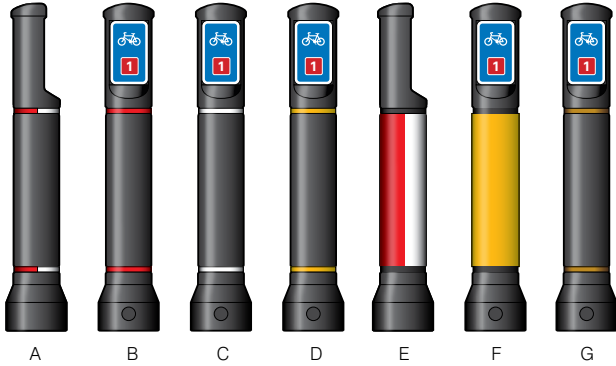

OPTIONAL BANDING

A. 2 x 20mm Red/White retroreflective bands*

B. 2 x 20mm Red retroreflective bands*

C. 2 x 20mm White retroreflective bands*

D. 2 x 20mm Amber retroreflective bands*

E. 1 x 485mm Red/White body sleeve
(3 x 150mm bands are available for use with Neopolitan Signhead Rebound models.)*

F. 1 x 485mm Amber body sleeve
(3 x 150mm bands are available for use with Neopolitan Signhead Rebound models.)*

G. 2 x 20mm Gold decorative bands

*All retroreflective materials supplied by Glasdon UK are as recommended in table NA1 of the National Annex of BS EN 12899-1:2007 Fixed Vertical Road Signs.

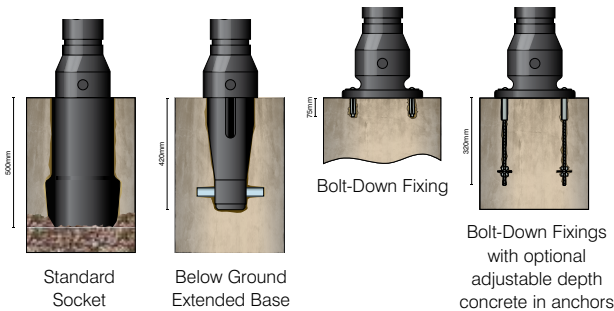

FIXING OPTIONS

Durapol Material: Standard Socket, Below Ground Extended Base, Bolt-Down Fixing, Bolt-Down Fixings with optional adjustable depth concrete in anchors.

Passively Safe Rebound Impactapol Material: Below Ground Extended Base, Bolt-Down Fixing and Bolt-Down Fixings with optional adjustable depth concrete in anchors.



Sign Carrying Bollards

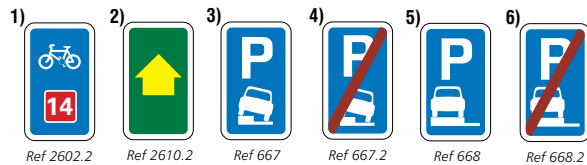

STANDARD PRICE SIGN OPTIONS

1. Numbered Cycle Route
2. Waymark
3. Vehicles may be parked partially on verge or footway
4. End of area where vehicles may be parked partially on verge or footway
5. Vehicles may be parked wholly on verge or footway
6. End of area where vehicles may be parked wholly on verge or footway

Recycled Material Bollards



Enviropol® recycled plastic material is manufactured predominantly from post-consumer plastics. By balancing these uncontaminated recycled waste materials, the result is a remarkably versatile product with many applications and benefits. Enviropol material will not chip or rust, is easy to clean and never needs painting.

Buffer™ Bollard is manufactured from 100% recycled rubber tyres and is pressure moulded to create a strong, hard-wearing, weatherproof material.



Buffer™ Bollard

DESIGN FEATURES

- Available in two heights - 600mm or 900mm.
- Reinforcing tube allows bollard to be flexible yet resilient.
- Recessed area for retroreflective or decorative banding.
- Made from 100% recycled rubber tyres.

SPECIFICATIONS

Height above ground: 600mm or 900mm
 Maximum diameter: 248mm
 Extended base depth below ground: 300mm



Black



Green

MATERIAL & COLOUR OPTIONS

Bollard: 100% recycled rubber car tyres in Black, Green.

Reinforcing tube: Galvanised mild steel.

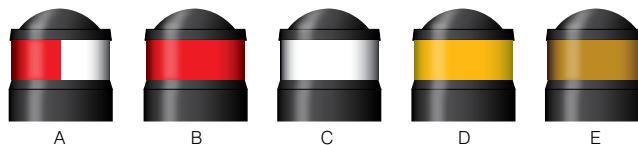
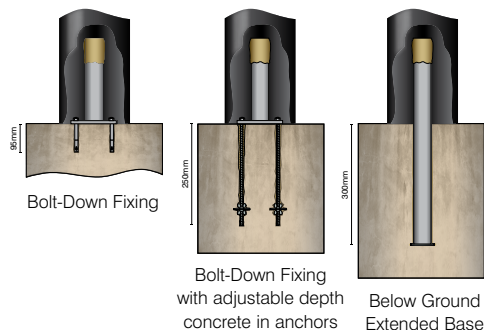

OPTIONAL BANDING

- 1 x 75mm Red/White retroreflective band*
- 1 x 75mm Red retroreflective band*
- 1 x 75mm White retroreflective band*
- 1 x 75mm Amber retroreflective band*
- 1 x 75mm Gold decorative band.

Ideal for personalisation with your crest, logo or message.

*All retroreflective materials supplied by Glasdon UK are as recommended in table NA1 of the National Annex of BS EN 12899-1:2007 Fixed Vertical Road Signs.

FIXING OPTIONS

Bolt-Down Fixing, Bolt-Down Fixing with adjustable depth concrete in anchors, Below Ground Extended Base.



Enviropol® Bollard

DESIGN FEATURES

- Flat or round top model.
- Recessed area for retroreflective or decorative banding.
- 100% recycled material.
- Below-ground extended base fixing.

SPECIFICATIONS

Height above ground: 1000mm
 Maximum diameter: 150mm
 Depth below ground: 500mm



Black

MATERIAL & COLOUR OPTIONS

Bollard: 100% recycled Enviropol Material in Black.

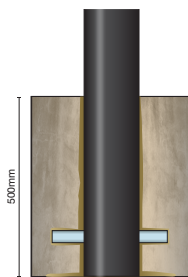

Below Ground
Extended Base

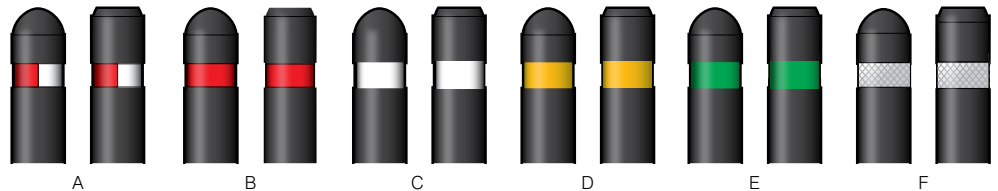

OPTIONAL BANDING

- A. 1 x 80mm Red/White retroreflective band*
- B. 1 x 80mm Red retroreflective band*
- C. 1 x 80mm White retroreflective band*

- D. 1 x 80mm Amber decorative band
- E. 1 x 80mm Green decorative band
- F. 1 x 80mm Silver decorative band

FIXING OPTIONS

Below Ground Extended Base.

*All retroreflective materials supplied by Glasdon UK are as recommended in table NA1 of the National Annex of BS EN 12899-1:2007 Fixed Vertical Road Signs.

Road Safety Signs



For use on bends and roundabouts, the Glasdon Chevreflex Ultra™ chevron boards meet passive safety standards, is proven to prevent accidents and cuts costs by outperforming traditional metal board and post chevron signs.

Chevreflex Ultra exceeds industry standards for motorcycle friendly, passively safe street furniture. Manufactured with Impactaflex™ material, it offers superior rigidity and resilience combined with class-leading recovery performance after a drive-through collision.



Chevroflex Ultra™ Sign System

DESIGN FEATURES

- Certified passively safe to Performance Standard NE3/100.
- Highly visible wall effect - offers a clear indication ahead of a bend or hazard in the road.
- New easy to install socket for quick and easy sign replacement.
- Three standard sizes of Chevron - 400mm, 600mm or 800mm.
- Modular socket design allows for unlimited number of Chevrons.
- Available as left-hand bend, right-hand bend, a roundabout unit with a statute-compliant 606 signface or a sight screen.
- Available with or without high-visibility border.
- AutoCAD model specifications available for all products.

MATERIAL AND COLOUR OPTIONS

- Uprights: Impactaflex™ Material
- Socket: Galvanised steel
- Uprights: Black.
- Hi-Vis surround: Yellow or Yellow/Green



1 Specify the size of your Chevrons and the number of Chevrons.

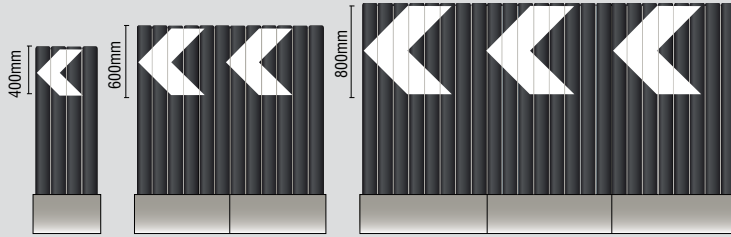

2 Specify the configuration of your Chevrons - left hand bend, right hand bend, roundabout (with statute-compliant 606 sign face)

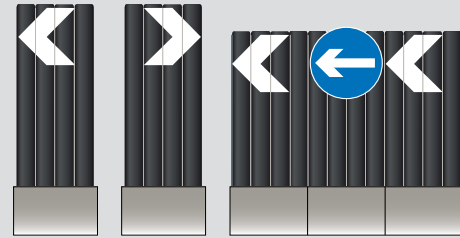

left hand bend

right hand bend

roundabout (with statute-compliant 606 sign face)

3 Choose with or without high visibility border -

Chevroflex Ultra with Hi-Vis surround is available with two different coloured borders, yellow/green and yellow. Made in Avery Dennison fluorescent Diamond Grade material, it is highly visible and reflective from a distance.*

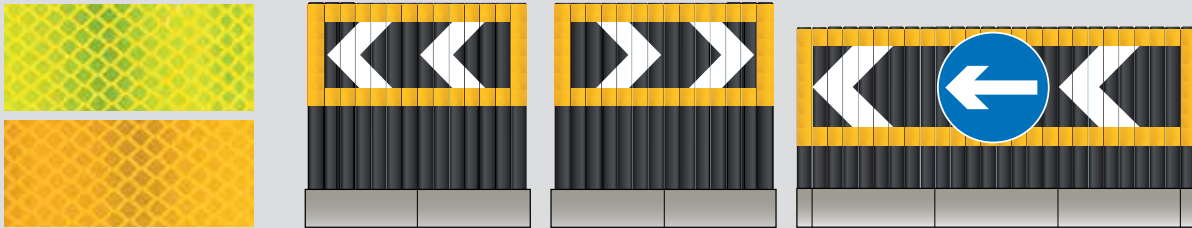

*All retroreflective materials supplied by Glasdon UK are as recommended in table NA1 of the National Annex of BS EN 12899-1:2007 Fixed Vertical Road Signs.

4 For roundabouts choose 606 directional arrows.

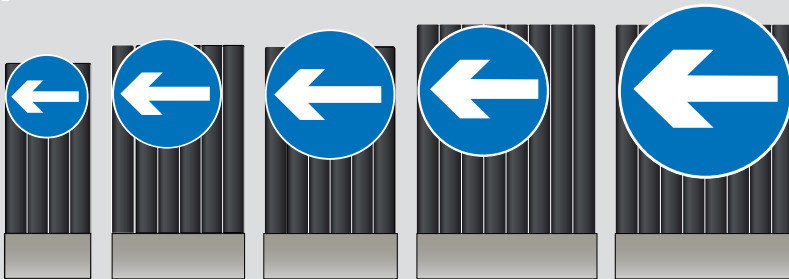

600mm 606 for use on 400mm roundabouts

750mm 606 for use on 600mm roundabouts

900mm 606 for use on 600mm roundabouts

900mm 606 for use on 800mm roundabouts

1200mm 606 for use on 800mm roundabouts

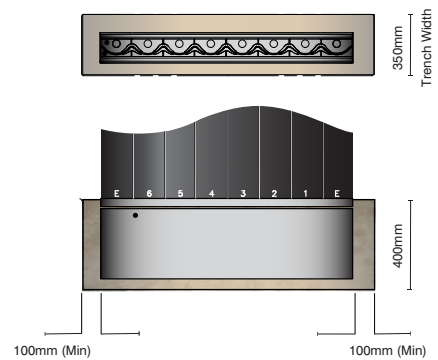

FIXING

The trench for the sockets should be 400mm deep, 350mm wide and 200mm longer than the overall length of the Chevroflex Ultra Sign.

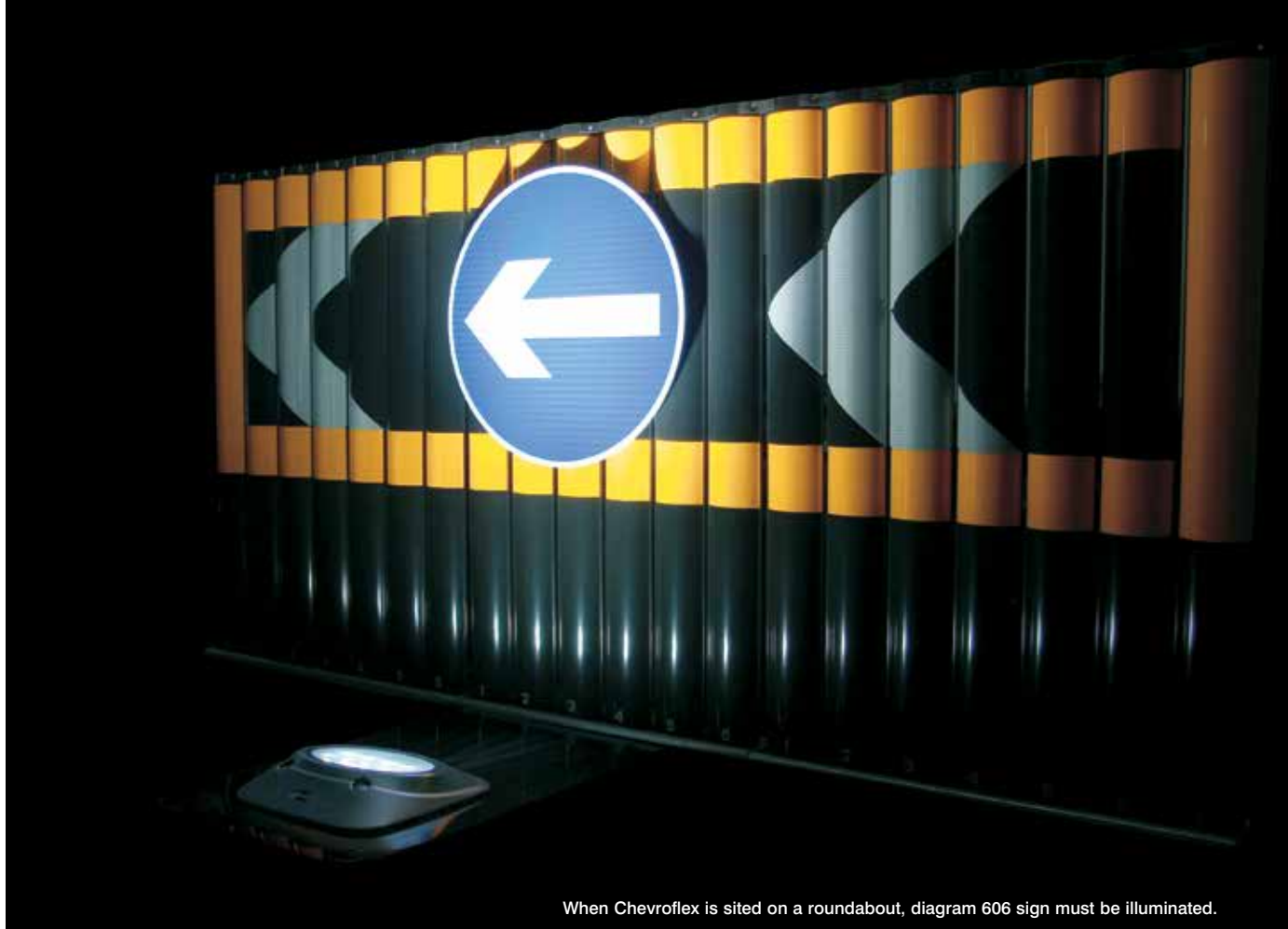

When Chevreflex is sited on a roundabout, diagram 606 sign must be illuminated.

Sublite Lumino™ Led Uplighter

DESIGN FEATURES

- Flush ground uplighter removes the potential impact hazard created by a traditional post-mounted downlighter.
- Low energy and low maintenance - only 12w power consumption.
- Highly resilient: 100% recycled Durapol polymer IP67 rated.
- Versatile: Hinged LED plate allows adjustment after installation.
- Designed to withstand accidental drive-over.



Road Safety Vergeposts

Glasdon hazard marker posts are ideal delineators for highlighting road layouts in urban traffic environments and bends on rural or trunk roads.

The Vergemaster RX™ Marker Post, is a passively safe verge marker with a wide-angle reflector and a range of fixing options to suit any terrain. For urban environments, the heavy duty, passively safe Hazardmaster™ Marker Post is robustly designed to withstand repeated wheel-over collisions.



Vergemaster RX™ Marker Post

DESIGN FEATURES

- Passively safe Reflexapol® Material construction.
- Extended base fixing model successfully tested to Performance Standard NE4/100 by TRL.
- Two arced microprismatic Impactalight™ Reflectors increase reflective performance and viewing angles for clear delineation by day and night.
- Choice of fixing options available.

SPECIFICATIONS

Height above ground: (extended base/stake type)	920mm
(bolt-down).	886mm
Maximum diameter:	167mm
Depth below ground: (extended base)	350mm
(stake type)	523mm
(bolt-down).	100mm

*Below Ground Extended Base model only.



MATERIAL OPTIONS

Marker post: Reflexapol Material

Fixing stake: Pressure-treated timber

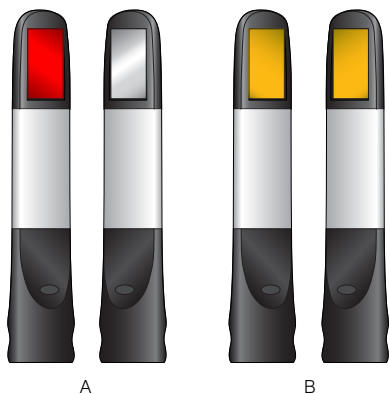

A

B

VERGEMASTER REFLECTOR OPTIONS

A. Red & White

B. Amber & Amber

*All retroreflective materials supplied by Glasdon UK are as recommended in table NA1 of the National Annex of BS EN 12899-1:2007 Fixed Vertical Road Signs.

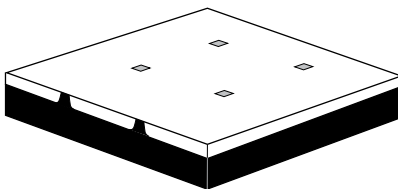

MOULDED-IN WHITE BAND SECTION OF MATERIAL

Integral white bands fused to the post with HEAT and COMPRESSION.

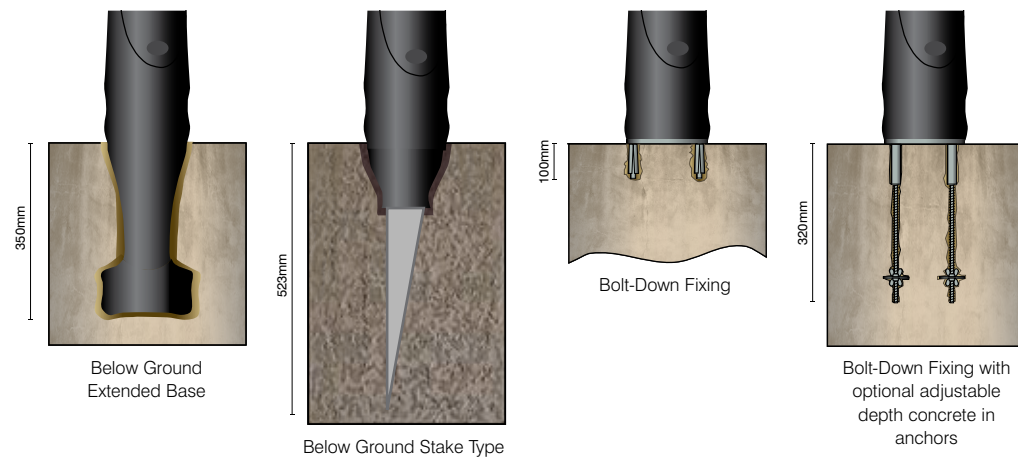

Below Ground
Extended Base

Below Ground Stake Type

Bolt-Down Fixing

Bolt-Down Fixing with
optional adjustable
depth concrete in
anchors

FIXING OPTIONS

Below Ground Extended Base, Below Ground Stake Type, Bolt-Down Fixing, Bolt-Down Fixing with optional adjustable depth concrete in anchors





Flexmaster™ Marker Post

DESIGN FEATURES

- Manufactured from highly durable Ultraflex™ Material that will withstand multiple vehicle impacts.
- White band and reflector provide maximum visibility.
- Standard fixing can be installed in soft ground without the need for excavation. Advanced fixing provides a socket that allows the post to be easily removed and reinstated without ground works.
- Offers infinite possibilities for low-maintenance, high-visibility signage.

SPECIFICATIONS

Height above ground:	905mm
Width:	150mm
Depth below ground:	405mm
(standard fixing)	405mm
(advanced fixing)	400mm



HIGHLY COMMENDED
The IHT/Highways Agency
Health & Safety at Work Award

MATERIAL OPTIONS

Marker post: Ultraflex Material.
Advanced socket fixing: Galvanised steel.

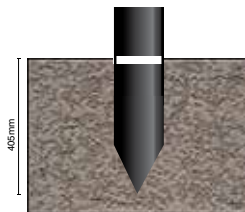

Standard Fixing Option

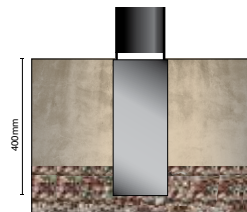

Advanced Fixing Option
(socketed)

FIXING OPTIONS

Standard Fixing Option
Advanced Fixing Option (socketed)

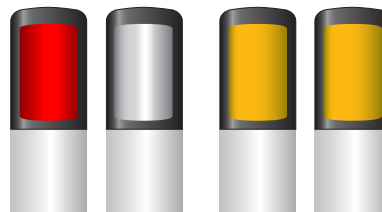

Red & White

Amber & Amber

FLEXMASTER REFLECTOR OPTIONS

*All retroreflective materials supplied by Glasdon UK are as recommended in table NA1 of the National Annex of BS EN 12899-1:2007 Fixed Vertical Road Signs.



OTHER APPLICATIONS

The versatility of the Flexmaster system offers infinite possibilities for low maintenance, high visibility signage.

To discuss your requirements please telephone our highways safety sales team on 1800 656 606



Hazardmaster™ Marker Post

DESIGN FEATURES

- Passively safe Impactapol Material construction for the highest risk areas.
- Successfully tested to Performance Standard NE4/100 by TRL.
- Substantial, robust marker post.
- Two large retroreflectors provide maximum visibility. Below-ground extended base fixing.

SPECIFICATIONS

Height above ground: 910mm
 Maximum diameter: 150mm
 Depth below ground: 300mm

MATERIAL OPTIONS

Marker post: Impactapol Material

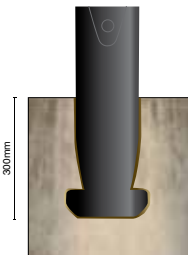

Below Ground
Extended Base

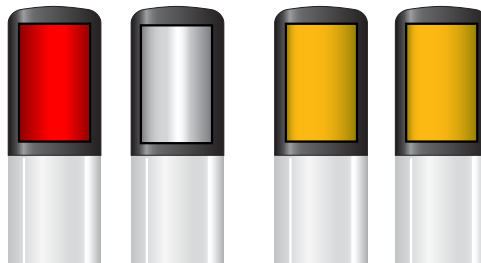

Red & White

Amber & Amber

HAZARDMASTER REFLECTOR OPTIONS

*All retroreflective materials supplied by Glasdon UK are as recommended in table NA1 of the National Annex of BS EN 12899-1:2007 Fixed Vertical Road Signs.



FIXING OPTIONS

Below Ground Extended Base.



Edgelineer™ Bollard

DESIGN FEATURES

- Available as a self-righting Rebound bollard or rigid Durapol material model.
- Recessed area for decorative or retroreflective banding (due to the low height of the bollard this is not approved for highways use).
- Co-ordinates with Neopolitan Bollards.
- Below-ground extended base fixing.

SPECIFICATIONS

Height above ground: 510mm
Maximum diameter: 140mm

MATERIAL OPTIONS

Rigid Bollard: Durapol Material.
Rebound Bollard: Impactapol Material.
(Black only).

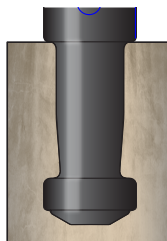
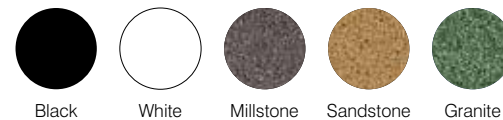

Below Ground
Extended Base

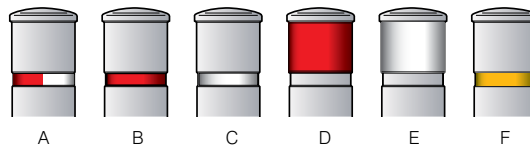

OPTIONAL BANDING

- A. 1 x 19mm Red/White retroreflective band.*
- B. 1 x 19mm Red retroreflective band.*
- C. 1 x 19mm White retroreflective band.*
- D. 1 x 98mm Red retroreflective band.*
- E. 1 x 98mm White retroreflective band.*
- F. 1 x 19mm Gold decorative band.

FIXING OPTIONS

Below Ground
Extended Base.

*All retroreflective materials supplied by Glasdon UK are as recommended in table NA1 of the National Annex of BS EN 12899-1:2007 Fixed Vertical Road Signs.





Edgemaster™ 20 Post

DESIGN FEATURES

- Recessed area for decorative or retroreflective banding (due to the low height of the post this is not approved for highways use).
- Ground level marker ensures the bollard is installed correctly.
- Below-ground extended base fixing available with or without optional ground fixing peg.

SPECIFICATIONS

Height above ground: 490mm
 Maximum diameter: 105mm
 Depth below ground: 340mm

MATERIAL OPTIONS

Post: Durapol® Material.



White

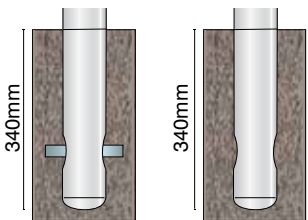

Below Ground Extended Base with optional ground fixing peg

Below Ground Extended Base without ground fixing peg

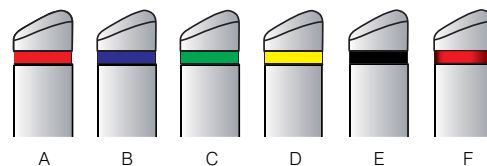

OPTIONAL BANDING

- 1 x 20mm Red decorative band.
- 1 x 20mm Blue decorative band.
- 1 x 20mm Green decorative band.
- 1 x 20mm Amber decorative band.
- 1 x 20mm Black decorative band.
- 1 x 20mm Red retroreflective band.*

*All retroreflective materials supplied by Glasdon UK are as recommended in table NA1 of the National Annex of BS EN 12899-1:2007 Fixed Vertical Road Signs.

FIXING OPTIONS

Below Ground Extended Base with optional ground fixing peg, Below Ground Extended Base without ground fixing peg





Glenwood™ Post

DESIGN FEATURES

- Manufactured from Everwood™ Material, which has a unique realistic timber grain effect.
- Lightweight and easy to install.
- Moulded-in saw grooves enable the post to be easily cut down to the desired height. Height options are 1000mm, 830mm and 500mm.
- 100mm vandal-resistant signfaces.
- Below-ground extended base fixing.

SPECIFICATIONS

Height above ground: 500mm, 830mm or 1000mm
 Width: 150mm
 Depth below ground: 400mm to 650mm



MATERIAL OPTIONS

Bollard: Everwood Material.

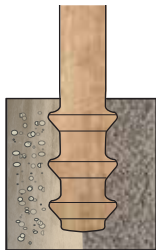

Below Ground
Extended Base

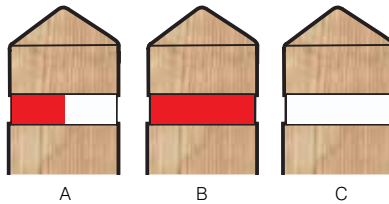

OPTIONAL BANDING

- A. 1 x 37mm Red/White retroreflective band*
 B. 1 x 37mm Red retroreflective band*
 C. 1 x 37mm White retroreflective band*

*All retroreflective materials supplied by Glasdon UK are as recommended in table NA1 of the National Annex of BS EN 12899-1:2007 Fixed Vertical Road Signs.

FIXING OPTIONS

Below Ground
Extended Base



Ref 955



Ref 956



Ref 957



Ref 957 Reversed

OPTIONAL SIGNFACES





Gateway Sign Carriers

Unlike recycled PVC units on the market, the Glasdon Gateway is integrally strong – no need for dangerous steel reinforcing poles.

We've been working with county councils and highway contractors all over the UK to supply personalised entrance features for villages, communities and parish councils.



Glasdon Gateway

DESIGN FEATURES

- A low maintenance, long-lasting alternative to traditional wooden sign carriers.
- Hundreds of combinations of colour, slats, widths and heights available - contact us for more information.
- 600mm speed limit signs are available as a standard kit for the Glasdon Gateway. Signs include National Speed Limit, 30MPH, 40MPH and 50MPH.

SPECIFICATIONS

Height: 1800mm (1300mm above ground) or 2300mm (1800mm above ground).
 Width: 960mm, 1500mm, 2000mm.
 Post Width: 160mm

MATERIAL OPTIONS

Posts/slats: Everwood Material.
 Fixing bolts: Stainless steel.



1 Specify the colour:
 Light Oak or Dark Oak for a wood effect, or white for maximum visibility.

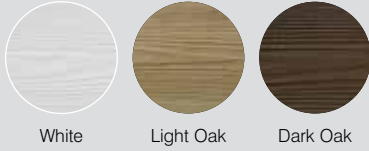

White Light Oak Dark Oak

2 Specify the width -
 Standard options 960mm, 1500mm or 2000mm.

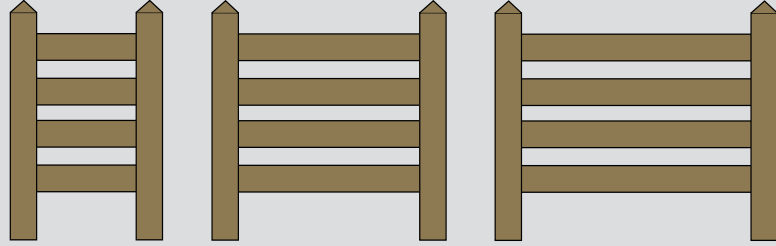

Width: 960mm, 1500mm or 2000mm

3 Specify how many slats:
 We can supply Glasdon Gateway with between one and four slats, with an optional crossbar for a traditional farm gate appearance.

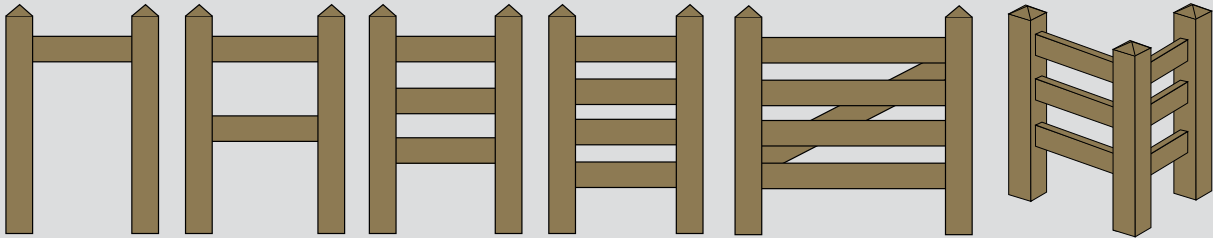

Number of Slats: Available with 1, 2, 3 or 4 slats.

Crossbar: Creates a traditional farm gate appearance.

L-Shaped: For a striking visual impact.

4 Choose a height: Standard options are 1800mm (1300mm above ground) or 2300mm (1800mm above ground)

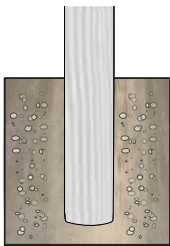

Below Ground
 Extended Base

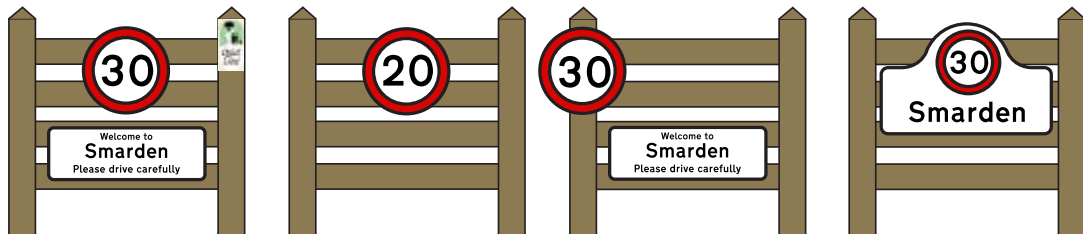

EXAMPLE SIGNAGE OPTIONS

Glasdon Gateway is supplied flat pack with comprehensive instructions for easy assembly. Attaching your existing signage to the product is a simple job, or we can supply a sign made to your specification. If you're not sure about the dimensions of Gateway you need, we can recommend the right size based on the measurements of the sign you want to display - contact us for more information.

FIXING OPTIONS
 Below Ground
 Extended Base

Other Road Safety Products



Pooling water can be dangerous to road users and the standing water can penetrate the road structure, causing severe damage, particularly on rural roads where there are generally fewer drains. In freezing conditions ice is created and expands creating cracks and pot holes in the road surface. Pot holes can create a major hazard and are very time consuming and costly to repair.

The Drainagemaster™ Drainage Grip is a lightweight, moulded highway drainage product that offers a more efficient solution to draining water from the roads surface.



Drainagemaster Drainage Grip

DESIGN FEATURES

- Efficiently channels running and pooling water from rural road surfaces into a parallel drainage ditch.
- Robust side ridges allow vehicles to drive over the unit without damage.
- Quick and easy to install.
- Requires minimal maintenance - the wide, smooth surface discourages the build-up of debris and is easily cleared with a shovel or brush.
- Reflective patches are available so the unit can be easily located for maintenance checks.
- An extension channel is also available.
- For quantities over 5 please contact our sales office for the best prices.

SPECIFICATIONS

Width: 762mm Depth: 900mm Maximum height: 155mm

MATERIAL OPTIONS

Drainagemaster: Durapol Material Ground pegs: Polypropylene.



Fixing Options & Materials

With a choice of up to six different fixing methods, there is sure to be one that is right for your application.

Our highways safety products are made from a range of high performance materials and undergo stringent checks to ensure durability and best value.

Glasdon has ISO9001:2008 and ISO4001:2004 accreditation, which underlines our commitment to quality.

LockFast™ Socket System

The new LockFast Socket System is the first Glasdon socket compatible with passively safe Impactapol bollards. The square shape prevents twisting during an impact and is easy to pave around. Bollards are quick and easy to remove and replace, making them ideal for permanent, semi-permanent, or temporary applications. The socket will absorb the impact of most collisions, leaving the surrounding surfaces undamaged.

SAFETY NOTICE:

If the removal of a bollard creates a safety hazard, we strongly recommend the purchase of a socket blanking cap, which features a slip resistant finish.

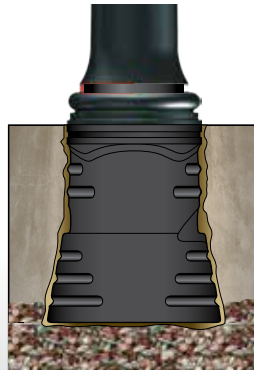

Locking Blanking Cap



Temporary Blanking Cap

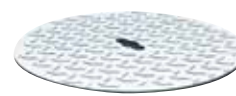

Moulded-in product code aids correct bollard top replacement.

Square shape prevents twisting during a drive through and is easy to pave around.

Moulded-in arrow and logo aids correct installation.

Made from Durapol polymer, a proven corrosion-resistant and impact-resistant material and fully recyclable after its long service life.

Anchor points help to prevent uprooting.

Flat base - much easier to level.



Galvanised mild steel blanking plate removes trip hazard and aids installation.



Only 350mm deep for quicker installation.

The first Glasdon socketed bollard proven passively safe to Performance Standard NE4/100.



PASSED
at 100 Km/h
(62mph) ✓

Standard Socket System

Glasdon socketed bollards are quick and easy to remove and replace, making them ideal for permanent, semi-permanent, or temporary applications. The socket will absorb the impact of most collisions, leaving the surrounding surfaces undamaged.

SAFETY NOTICE:

If the removal of a bollard creates a safety hazard, we strongly recommend the purchase of a socket blanking cap, which features a slip resistant finish.

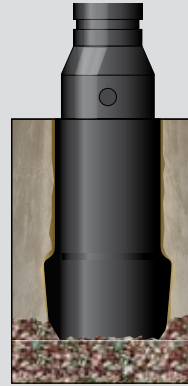

Locking Blanking Cap

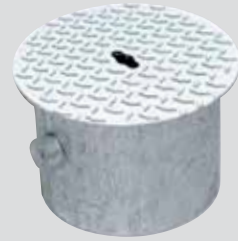

Below-Ground Extended Base

The extended base and horizontal ground peg of the bollard are secured in concrete for permanent installation.

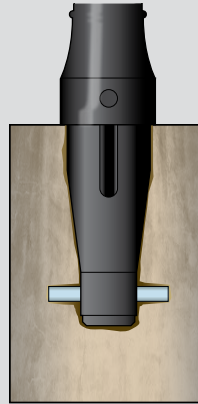

Bolt Down Fixing

Bolt-down fixings allow a bollard to be installed on existing concrete sub-surfaces in less than 8 minutes. Bolt-down fixing is ideal for use where below-ground installation is restricted or impossible.

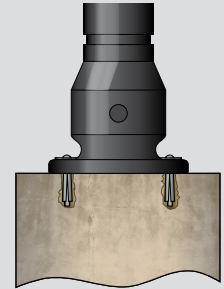

Bolt Down Fixings with Adjustable Depth Concrete-in Anchors

Concrete-in anchors offer additional anchorage and provide a permanent fixing point that allows bollards to be removed and reinstated without the need for additional groundwork. Optional adjustable depth concrete-in anchors can be used anywhere a fresh concrete sub-surface can be laid.

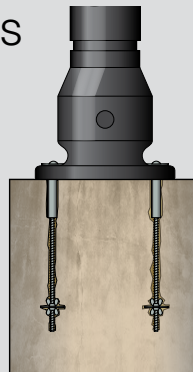

Guardsman™ Anti-Ram Raid Bollard Fixing

A galvanised steel reinforcing tube extends 745mm below ground level, providing an integral root for superb strength and impact resistance. This tube is then filled with concrete. The bollard top is securely attached with hidden coupling bolts. Guardsman bollards are an excellent security feature and have been shown in tests to stop an unladen van dead at speeds of up to 30mph.

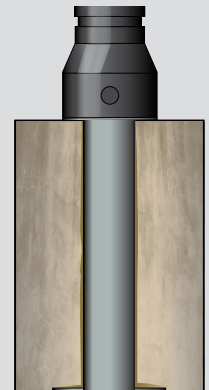

High Performance Materials

Glasdon bollards are manufactured from a range of high performance materials and undergo stringent checks to ensure durability and best value. Glasdon has ISO 9001:2008 and ISO 14001:2004 accreditation, underlining our commitment to quality.

Durapol® Polymer

A strong, lightweight material that offers a number of advantages over traditional materials. Durapol material is self coloured, which means it will never need painting and scratches will not show. The material is totally corrosion-free so it will not chip or rust, and is vandal resistant.



Durapol Material



Other Material

Passively Safe Impactapol® Polymer

A flexible material with excellent recovery performance, meaning it will return to its original shape following a drive-through collision. Impactapol products reduce maintenance budgets in vulnerable locations by continuing to perform to statutory requirements even after repeated impacts. Impactapol offers all the additional benefits of Durapol – it is self-coloured and totally corrosion-free.



Impactapol Material



Other Material

Impactaflex™ material has been specially developed by Glasdon to provide new Chevreflex Ultra™ with superior rigidity and resilience, and offers exceptional recovery performance after a drive-through collision. *(Chevreflex Ultra see page 31-33)*

Reflexapol® polymer is specially engineered for long service life in exposed locations. It has good recovery properties and will never need painting. *(Vergemaster RX see page 36-37)*

Ultraflex™ polymer is formulated to withstand harsh environments and has enhanced flexibility and extensibility properties offering good recovery performance after vehicular impact. *(Flexmaster see page 38)*

Enviropol® recycled plastic material is manufactured predominantly from post-consumer plastics. By balancing these uncontaminated recycled waste materials, the result is a remarkably versatile product with many applications and benefits. Enviropol material will not chip or rust, is easy to clean and never needs painting. *(Enviropol see page 30)*



Buffer™ Bollard is manufactured from 100% recycled rubber tyres and is pressure moulded to create a strong, hard-wearing, weatherproof material. *(Buffer see page 29)*



Everwood™ material is a realistic timber grain polymer, which requires minimal maintenance. Everwood is vandal and weather resistant, will not rot, warp or crack. *(Glasdon Gateway and Glenwood see page 42-45)*

Photo Gallery

Our customers often approach us to help solve unique problems, and we are always happy to help. Have a look at some of our road safety products at work.







Solar Signmaster™

Zero Energy, Smart Performance



www.glasdon.com



Visit our website to see our full range of Passively Safe products. Downloadable product literature, case studies and video clips are also available. Auto CAD model specifications are available on all products.

Glasdon
Glasdon International Limited

 Innovation and Export Centre
 Preston New Road
 BLACKPOOL
 Lancashire
 FY4 4UY

 Freephone: 1800 656 606
 E-mail: sales@glasdon.ie
 Web: www.glasdon.com

 **Glasdon**, Admiral, Advanced Neopolitan, Buffer, Chevrolflex Ultra, Drainagemaster, Durapol, Edgeliner, Edgemaster, Ensign, Enviropol, Everwood, Flexmaster, Glasdon Manchester, Glenwood, Guardsman, Hazardmaster, Impactaflex, Impactalight, Impactapol, Infomaster, Jubilee, LockFast, Mini Ensign, Neopolitan, Neopolitan Signhead, Reflexapol, Sublite Lumino, Ultraflex, Vergemaster RX and Victory are trademarks or registered trademarks of GLASDON Group or its subsidiaries in the UK and other countries.